

Design Trims, Panels, Profiles

- Highlights for Classic and Contemporary designs -

Ready to install: V-cut profiles of perfect geometry from Stainless Steel in various finishes and PVD colors.

Applications: Glass, Marble, Tiles installations, Furniture, Doors, Columns, Walls, Ceiling, Gift boxes, etc.

Production



Ti(PVD) coating



6m. V-groove



Profile bending

Custom V-cut Profiles (project specification example)

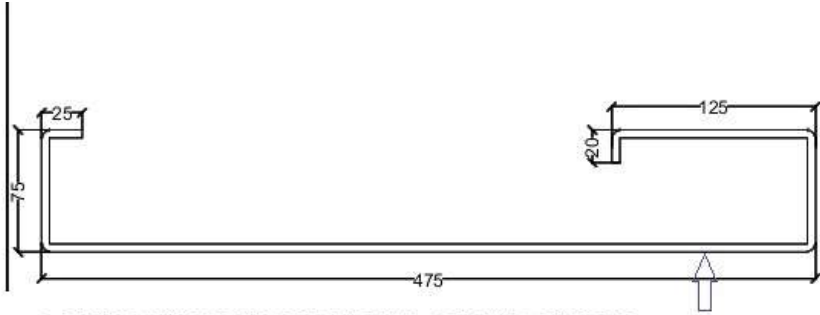

001 1.2MM THK FRAME IN NICKEL SILVER FINISH
002 LENGTH 3.3 M = 6 NOS.
003 LENGTH 2.86 M = 14 NOS.
003 LENGTH 4m. = 1 NO.

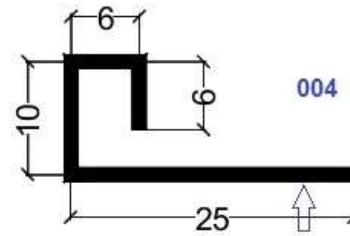

004
 1.2MM THK PROFILE
 IN NICKEL SILVER FINISH
 LENGTH 2.4M = 50 NOS.

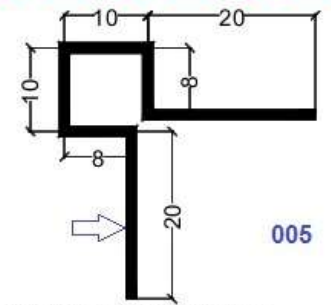

005
 1.2MM THK PROFILE
 IN NICKEL SILVER FINISH
 LENGTH 3.1M = 60 NOS.

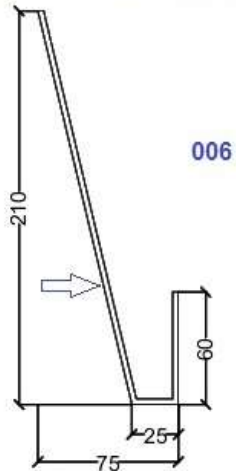

006
 1.2MM THK FRAME IN
 NICKEL SILVER FINISH
 LENGTH 2.15 M = 144 NOS.

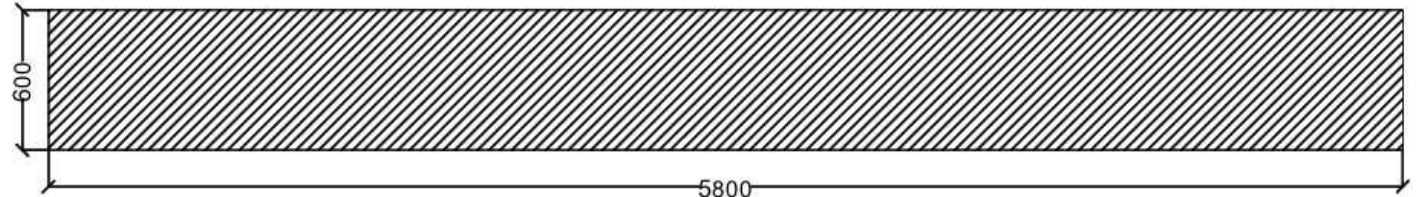

007

NICKEL SILVER FINISH METAL SHEET
 5.8 X 0.6 M = 4 NOS.
 600 x 2900mm. (8pcs.)

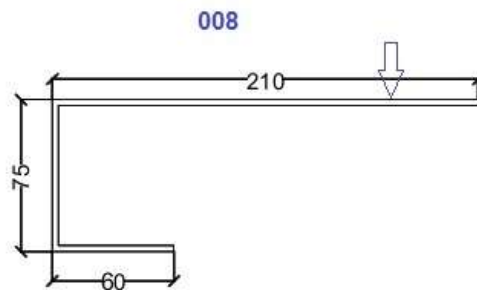

008
 1.2MM THK FRAME IN
 NICKEL SILVER FINISH
 LENGTH 1.5 M = 72 NOS.

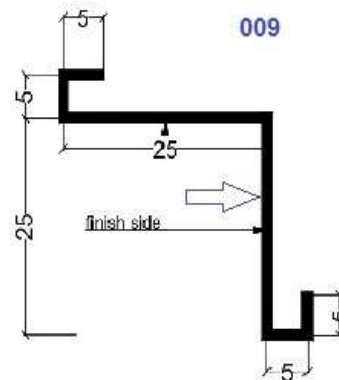

009
 1.2MM THK PROFILE
 IN NICKEL SILVER FINISH
 LENGTH 3 M = 205 NOS.

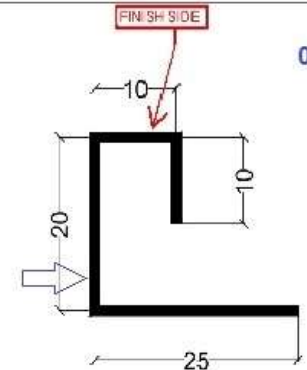

010
 1.2MM THK PROFILE
 IN NICKEL SILVER FINISH
 LENGTH 2.4 M = 20 NOS.

Hi-End slim profiles, resembling Solid bars



Hi-End slim profiles, resembling Solid bars

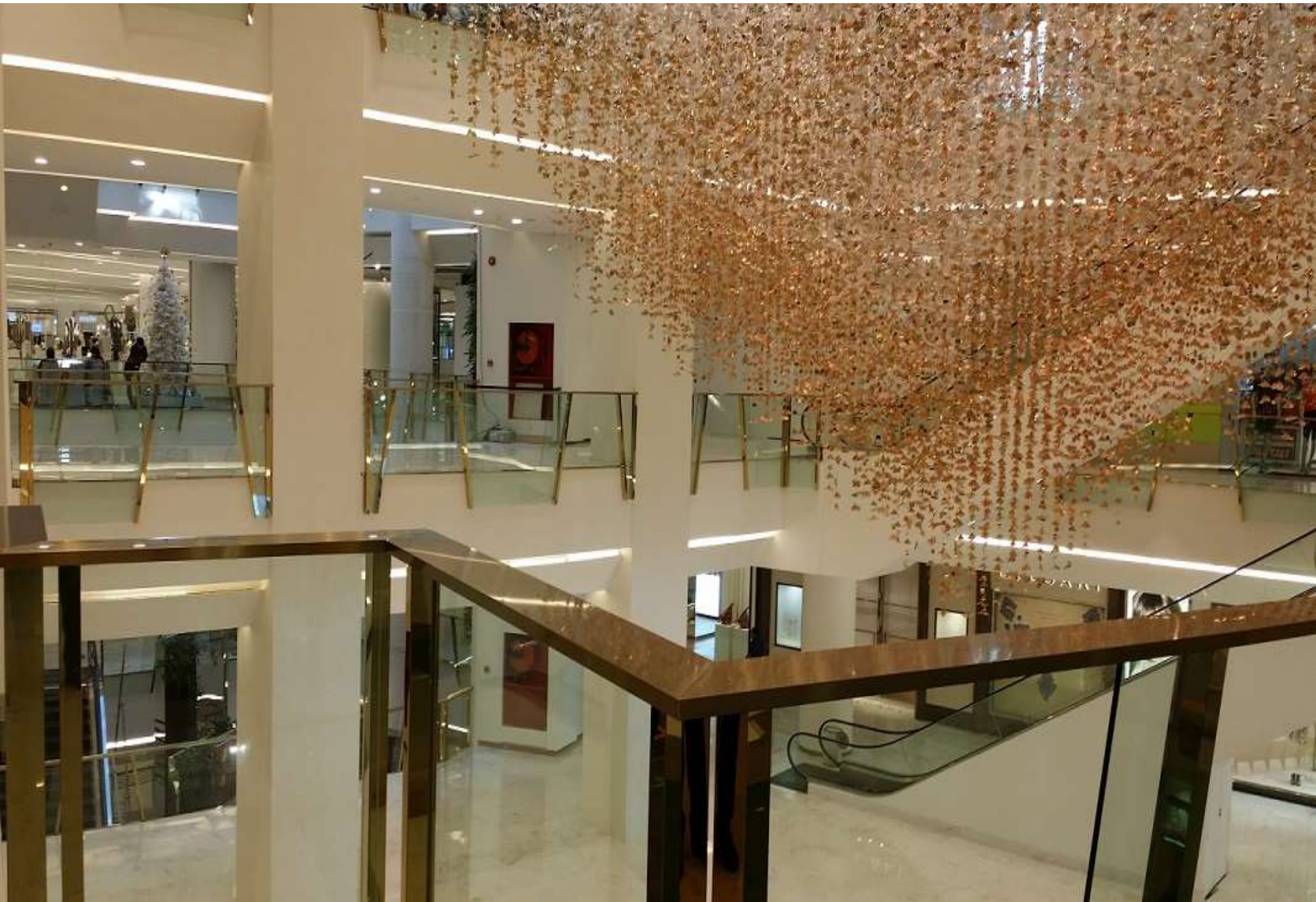

Lamella profiles, Patina finishes

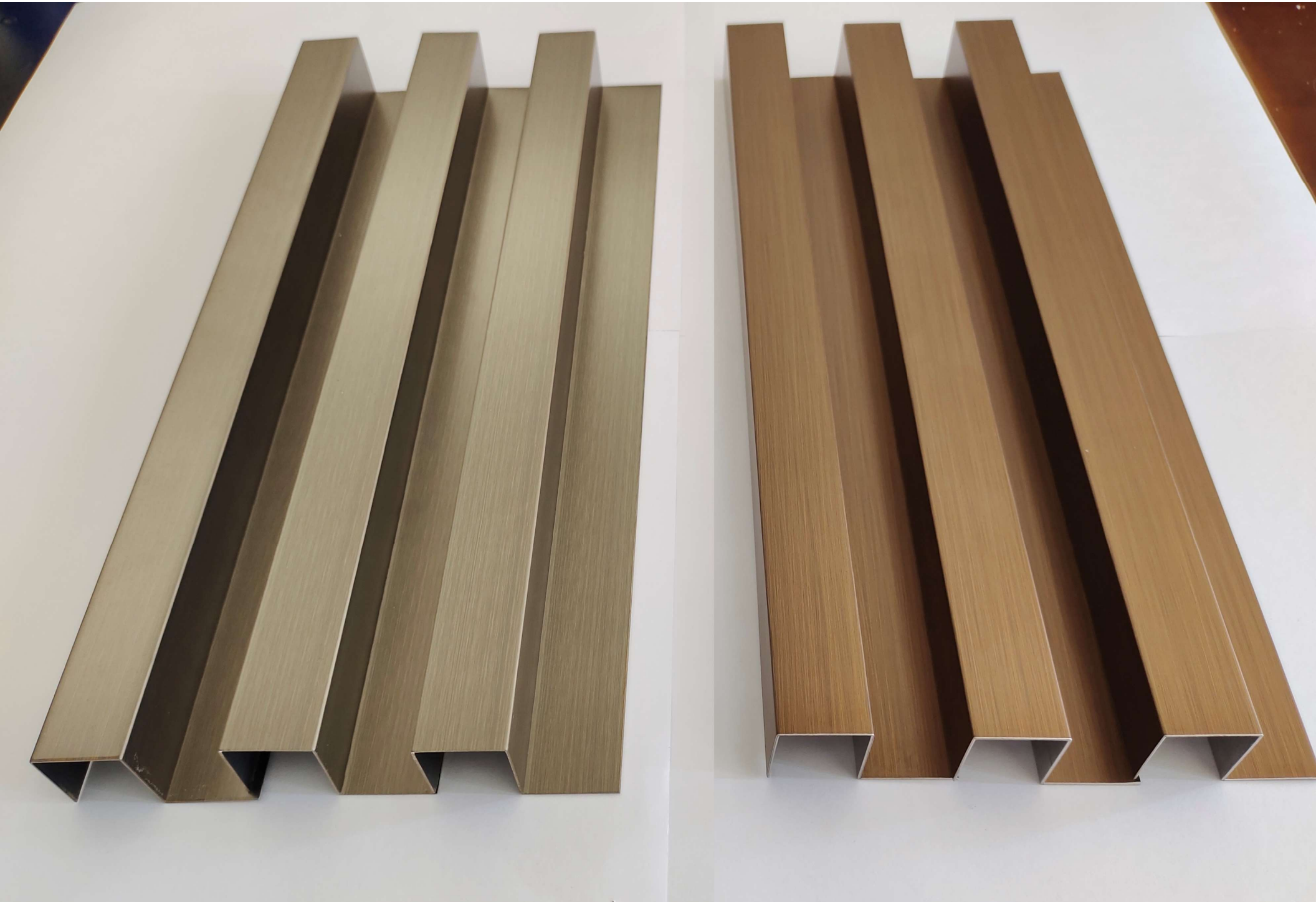

V-cut U-channels



GOLDEN TRIMS

Stainless steel **Mirror Gold** Profiles

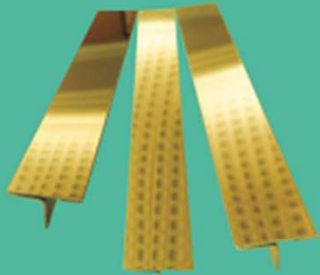

T-Shape

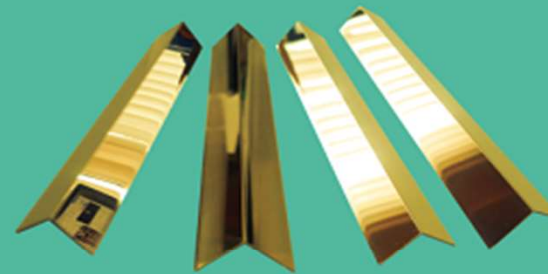
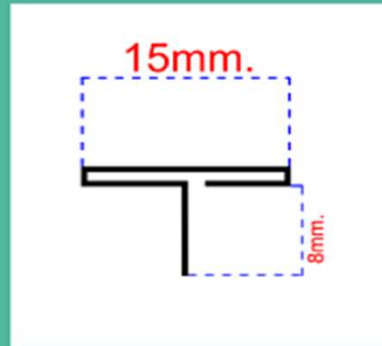

L-Shape

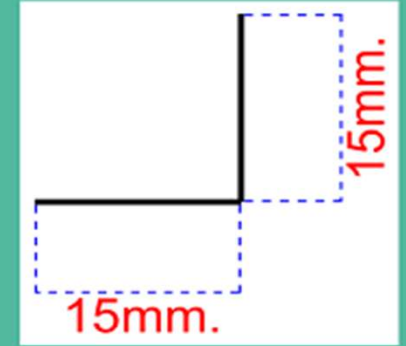

Before After

Marble



Tiles

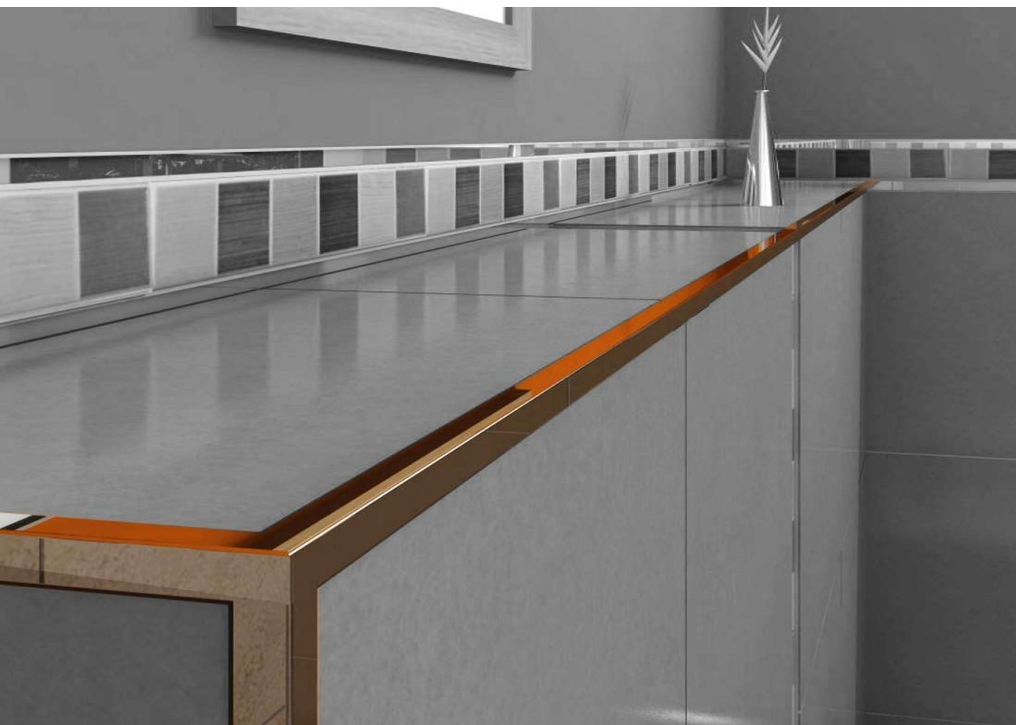

Furniture

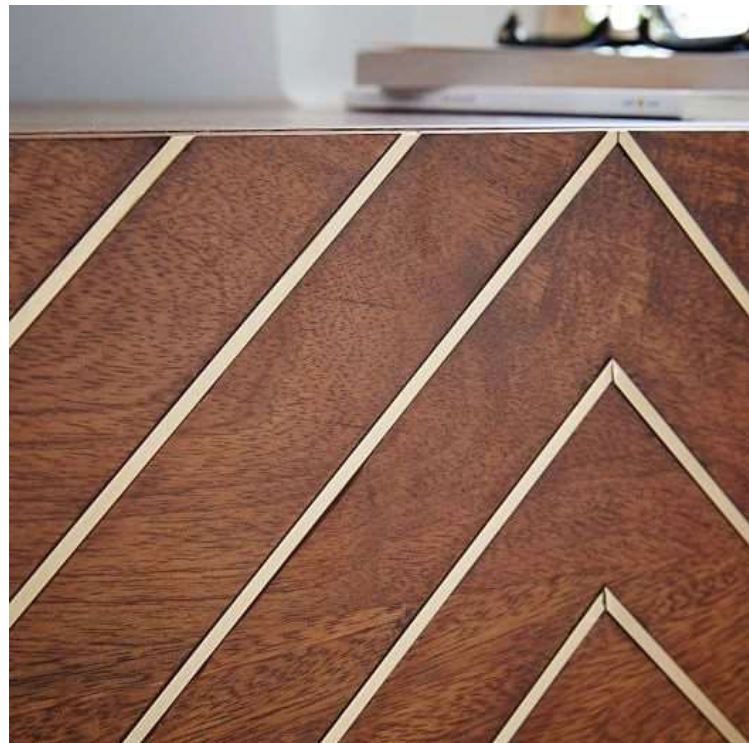

Doors

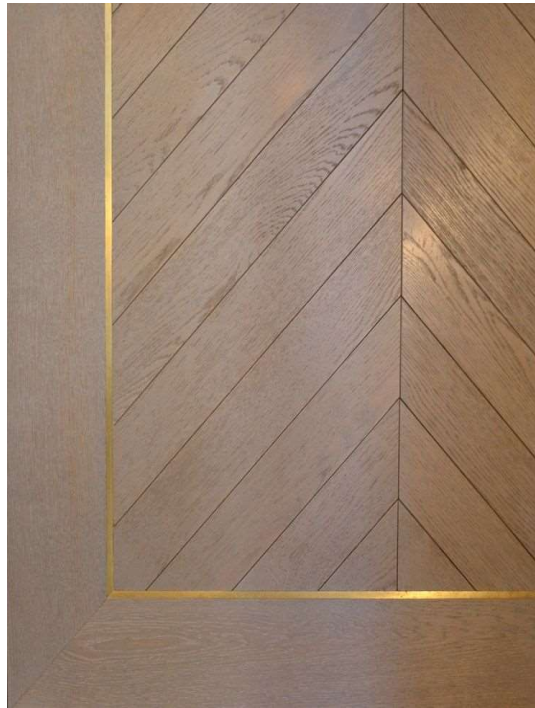

Columns and Walls

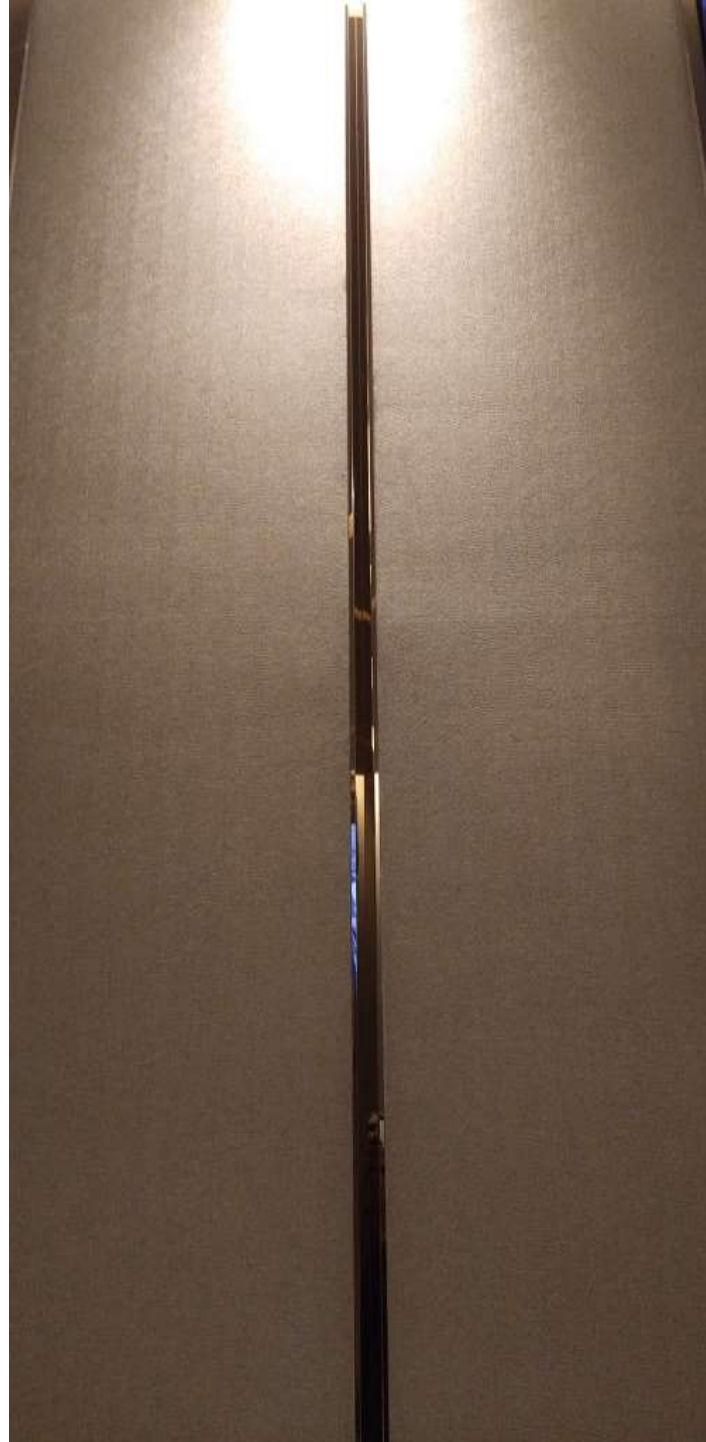

Columns, Walls and Ceiling



Elevators



Various



